



Russell Hobbs



25501

 www.russellhobbs.com

Register online for an EXTRA year guarantee

Visit www.russellhobbs.co.uk/productregister/ You must register within 28 days of purchase

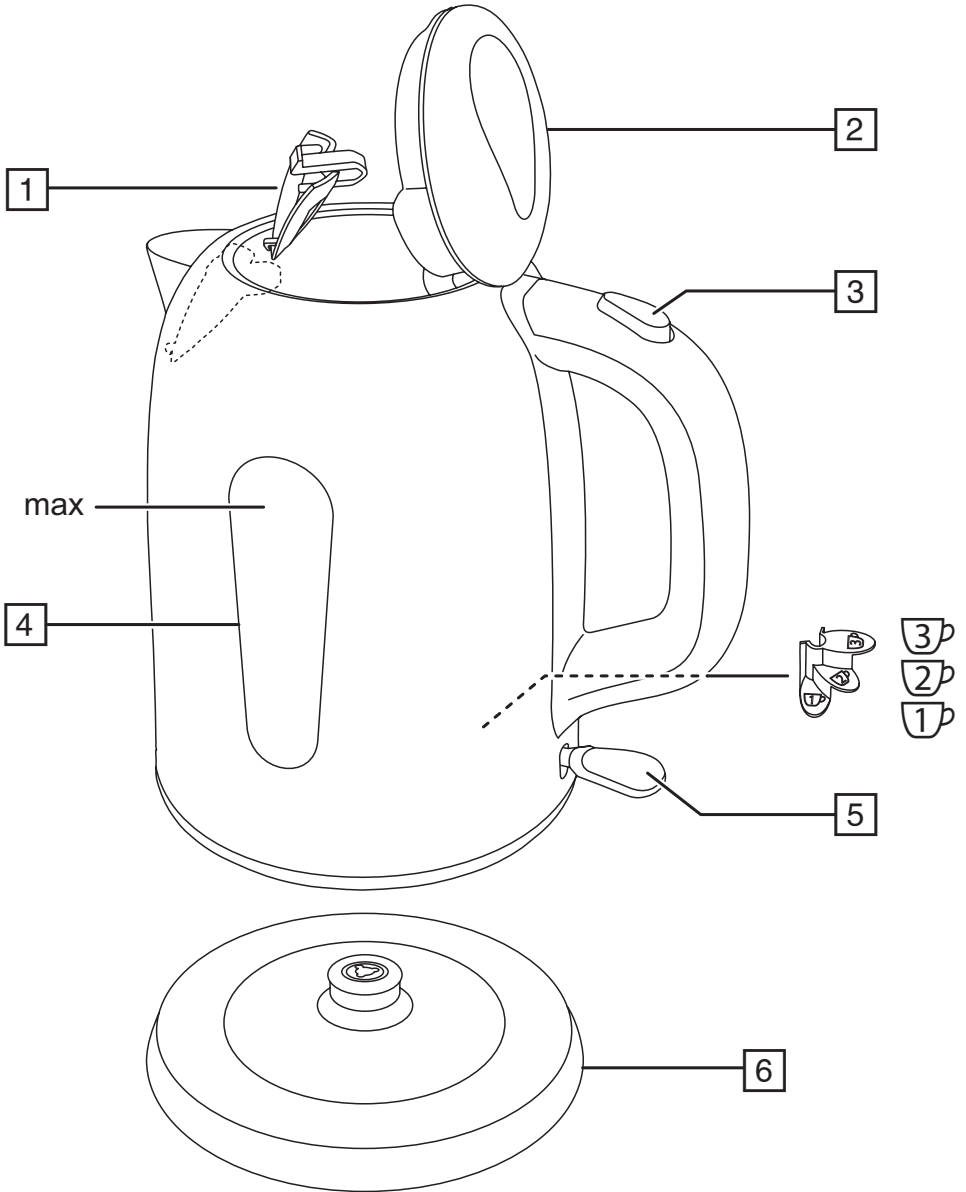

Read the instructions, keep them safe, pass them on if you pass the appliance on. Remove all packaging before use.

IMPORTANT SAFEGUARDS

Follow basic safety precautions, including:

This appliance can be used by children aged from 8 years and above and persons with reduced physical, sensory or mental capabilities or lack of experience and knowledge if they have been supervised/instructed and understand the hazards involved. Children shall not play with the appliance.

Cleaning and user maintenance shall not be done by children unless they are older than 8 and supervised.

Keep the appliance and cable out of reach of children under 8 years.

 Parts of the appliance will get hot during use.

If you overfill, the kettle may spit boiling water.

Use the kettle only with the stand supplied (and vice versa).

If the cable is damaged, it must be replaced by the manufacturer, its service agent, or someone similarly qualified, to avoid hazard.

Avoid spillage on the stand/connector.

The surface of the heating element is subject to residual heat after use.

Use the appliance according to these instructions. Any misuse may cause potential injury, electric shock or other hazards.

This appliance is intended to be used in household and similar applications such as:

- staff kitchen areas in shops, offices and other working environments;
 - by clients in hotels, motels and other residential type environments;
 - bed and breakfast type environments;
 - farm houses.
-  Do not use this appliance near bathtubs, showers, basins or other vessels containing water.
- Don't use the kettle for any purpose other than heating water.
 - Don't operate the appliance if it's damaged or malfunctions.

PARTS

- | | |
|----------------|----------------------|
| 1. Filter | 4. Water level gauge |
| 2. Lid | 5. Switch |
| 3. Lid release | 6. Stand |

BEFORE USING FOR THE FIRST TIME

Fill to **max**, boil, discard the water, then rinse. Do this twice to remove any manufacturing dust, etc.

FILLING

1. Open the lid.
2. Fill with at least 1 cup of water, but not above max.
3. If you want only 1, 2, or 3 cups of water, fill to the 1, 2, or 3 marks inside the kettle.
4. Close the lid. Always close the lid when boiling the kettle.

USING YOUR KETTLE

1. Put the stand on a stable, level surface.
2. Plug the stand into the wall socket.
3. Put the kettle on the stand.
4. Move the switch to **I**.
5. The light will come on and the kettle will start to heat up.
6. When the water boils the kettle will switch off.
7. To switch off manually, move the switch to **O**, or simply lift the kettle off the stand.

GENERAL

Note: When you lift your kettle, you may see moisture on the stand. This is normal and is caused by the steam used to switch your kettle off automatically.

BOIL DRY PROTECTION

If your kettle boils dry, a safety cut-out device will automatically switch it off. If this happens, unplug your kettle and allow it to cool down until the cut-out resets itself. Allowing your kettle to boil dry will shorten the life of the element.

CARE AND MAINTENANCE

1. Unplug the stand, and let the kettle cool before cleaning.
2. Wipe all surfaces with a clean damp cloth.
3. Keep the connectors dry.
4. Push the hook on top of the filter down then lift the filter out of the kettle.
5. Rinse the filter under a running tap while brushing with a soft brush.
6. Lower the filter into the kettle, and engage the bottom hook in the bottom of the spout.
7. Press the top of the filter towards the kettle, to lock the hook in place.
8. Close the lid.

Descale regularly, (at least monthly).

- Descale the appliance at least monthly with a proprietary descaler. Follow the instructions on the package of descaler.
- Products returned under guarantee with faults due to scale will be subject to a repair charge.

RECYCLING



To avoid environmental and health problems due to hazardous substances, appliances and rechargeable and non-rechargeable batteries marked with one of these symbols must not be disposed of with unsorted municipal waste. Always dispose of electrical and electronic products and, where applicable, rechargeable and non-rechargeable batteries, at an appropriate official recycling/collection point.

SERVICE

If you ring Customer Service, please have the Model Number to hand, as we won't be able to help you without it. It's on the rating plate (usually underneath the product).

The product isn't user-serviceable. If it's not working, read the instructions, check the plug fuse and main fuse/circuit breaker. If it's still not working, consult your retailer.

If that doesn't solve the problem – ring Customer Service – they may be able to offer technical advice.

If they advise you to return the product to us, pack it carefully, include a note with your name, address, day phone number, and what's wrong. If under guarantee, say where and when purchased, and include proof of purchase (till receipt). Send it to:

Customer Service

Spectrum Brands (UK) Ltd

Fir Street, Failsworth, Manchester M35 0HS

email: support@russellhobbs.com

telephone: 0345 658 9700 (local rate number)

Please note: If you have purchased the product within the last 6 months, please contact the retailer in the first instance to deal with any matters relating to warranty.

GUARANTEE

Defects affecting product functionality appearing within the guarantee period will be corrected by replacement or repair at our option provided the product is used and maintained in accordance with the instructions. Your statutory rights are not affected.

Guarantee period = 2 years from first retail purchase.

To claim an extra 1 year guarantee, register your product online within 28 days of purchase.

Register at: www.russellhobbs.co.uk/productregister/

Consumables are guaranteed only for their recommended lifecycle. Replacement/Spare parts* are excluded and are only covered by a 1 year warranty.

* Examples include filters, removable grill plates, drip trays/crumb trays etc.

ONLINE

www.russellhobbs.com for more products

REGISTER ONLINE

Register online for an EXTRA year guarantee*.

Visit www.russellhobbs.co.uk/productregister/

*You must register within 28 days of purchase.