

# Russell Hobbs

A BRITISH ICON SINCE 1952

26452

 [www.russellhobbs.com](http://www.russellhobbs.com)

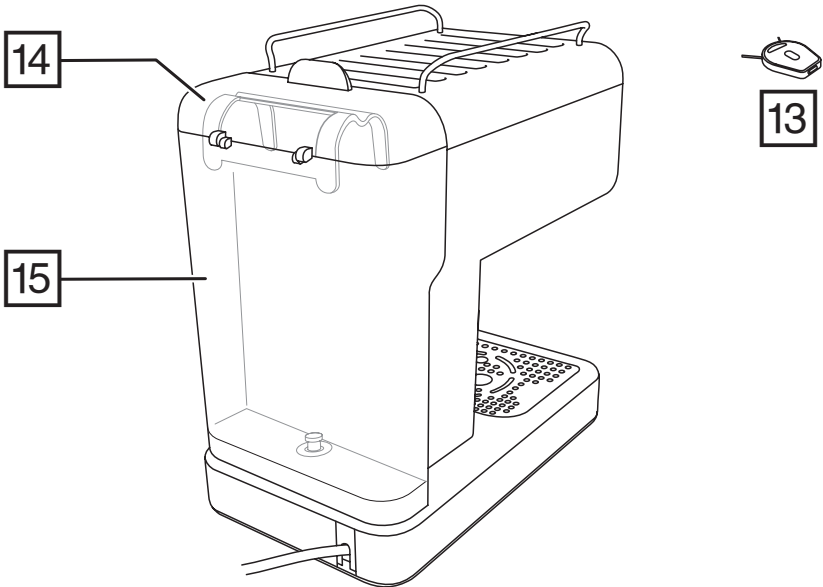
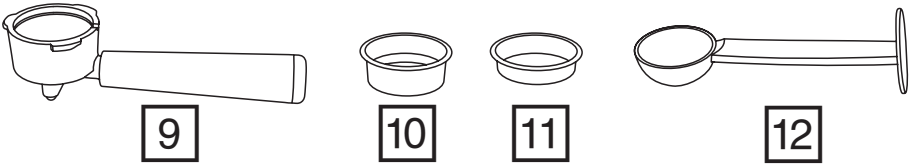
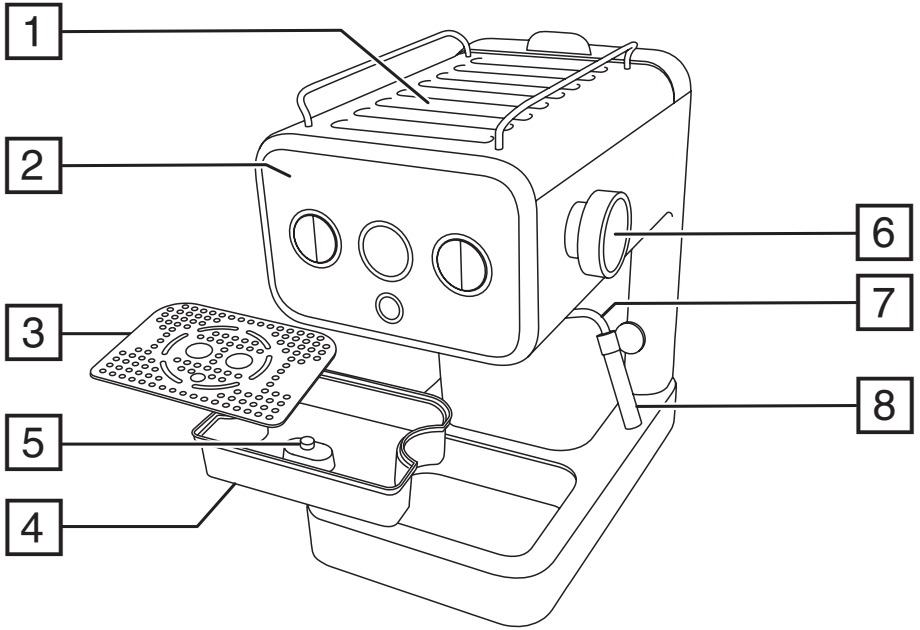

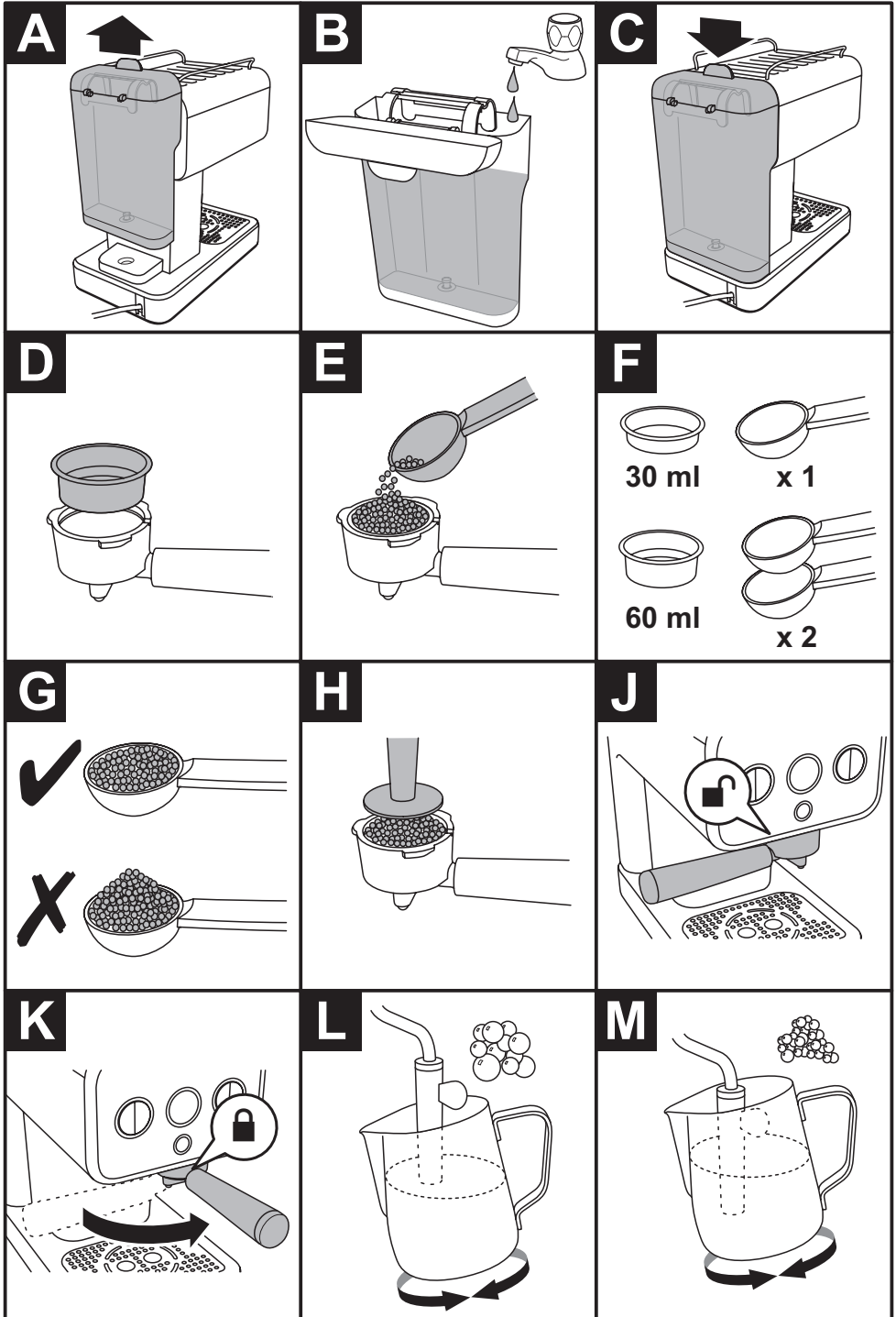

Read the instructions, keep them safe, pass them on if you pass the appliance on. Remove all packaging before use.

---

## **IMPORTANT SAFEGUARDS**

Follow basic safety precautions, including:

This appliance can be used by children aged from 8 years and above and persons with reduced physical, sensory or mental capabilities or lack of experience and knowledge if they have been supervised/instructed and understand the hazards involved.

Children shall not play with the appliance.

Cleaning and user maintenance shall not be done by children unless they are older than 8 and supervised.

Keep the appliance and cable out of reach of children under 8 years.

Misuse of the appliance may cause injury.

The coffee-maker shall not be placed in a cabinet during use.

 The surfaces of the appliance will get hot. Residual heat will keep the surfaces hot after use.

If the cable is damaged, it must be replaced by the manufacturer, its service agent, or someone similarly qualified, to avoid hazard.

The surface of the heating element is subject to residual heat after use.

Use the appliance according to these instructions. Any misuse may cause potential injury, electric shock or other hazards.

This appliance can be used by persons with reduced physical, sensory or mental capabilities or lack of experience and knowledge if they have been given supervision or instruction concerning use of the appliance in a safe way and understand the hazards involved.

Clean the product and all other accessories after each use.

 Do not immerse in any liquid.

This appliance is intended to be used in household and similar applications such as:

- staff kitchen areas in shops, offices and other working environments;
- by clients in hotels, motels and other residential type environments;
- bed and breakfast type environments;
- farm houses.

- Sit the appliance on a stable, level, heat-resistant surface.
- Don't use the appliance for any purpose other than those described in these instructions.
- Don't use the appliance if it's damaged or malfunctions.

---

## PARTS

- |                             |                    |
|-----------------------------|--------------------|
| 1. Cup warming plate        | 9. Portafilter     |
| 2. Control panel            | 10. 2 shot sieve   |
| 3. Drip tray cover          | 11. 1 shot sieve   |
| 4. Removable drip tray      | 12. Measure/tamper |
| 5. Drip tray full indicator | 13. Cleaning tool  |
| 6. Steam/hot water control  | 14. Water tank lid |
| 7. Swivel arm               | 15. Water tank     |
| 8. Removable steam nozzle   |                    |

---

## BEFORE USING FOR THE FIRST TIME

- Wash the portafilter, sieves and the measure/tamper in warm soapy water. Rinse and dry.
- Before using for the first time, or if the appliance has not been used for a long time, clean it by filling and running the appliance without coffee. Follow the instructions under FILLING and MAKING ESPRESSO but without adding any coffee.
- Clean the steam system by following the instructions under CARE AND MAINTENANCE.

---

## AUTO SHUTOFF

After 25 minutes of inactivity, your espresso maker will shut off. To turn it back on, press  $\phi$ .

---

## FILLING

1. Remove the water tank by lifting it upwards (Fig A).
2. Fill the water tank with cold, fresh water to the **max** marking (Fig. B).
3. Refit the water tank (Fig. C). Ensure it is correctly fitted and fully seated.

---

## MAKING ESPRESSO



Espresso can be enjoyed on it's own or used for many popular espresso based variations such as Latte, Cappuccino, Americano, etc. Your espresso maker can make a single shot (approx. 30ml), or a double shot (60ml) of espresso.

Your Espresso maker can make drinks automatically or under manual control.

### Filling the portafilter









1. Decide whether you are making a single shot or double shot.
2. For a single shot fit the 1 shot (smaller) sieve into the portafilter; for a double fit the 2 shot (larger) sieve (Fig. D). For ESE (easy serving espresso) pods use the 1 shot sieve.
3. Use the measure to fill the sieve (Fig. E). For a single shot use 1 measure and for a double use 2 measures (Fig. F). The coffee in the measure should be level and not heaped (Fig. G).
4. Lightly tamp (compress) the coffee into the portafilter using the flat end of the measure (Fig. H) until it is level. You need to compact the coffee just enough to create resistance to the water as it passes through the coffee. Too loose and the water passes easily through the coffee and the full flavour won't be extracted. Too tight and it will be difficult for the water to pass through the coffee and the flavour will be harsh and bitter.

## Fitting the portafilter

1. Make sure the rim of the portafilter is free from any coffee debris. Fit it into the machine with the handle facing out to the left so that is aligned with the  mark (Fig. J).
2. Push the portafilter upwards then turn it to the right until it stops (Fig. K).
- To remove the portafilter, turn it to the left until the handle lines up with the  mark.

## Automatic One and Two Cup Mode

Your Espresso maker can make one or two cups with just a single button press.

1. Fill the water tank, then add the required amount of coffee to the portafilter and fit it.
2. Press the  button to switch your Espresso maker on.
3. Your Espresso maker will start its pre-heat cycle. The six segments in the display and the  icon will light up. The first segment will flash. The flashing segment will go off and the next anticlockwise segment will flash. When all of the segments have gone off, and the  icon comes on, your Espresso maker is heated and ready.
4. Place one or two cups onto the drip tray.
5. For one cup, press the  button; for two cups press the  button.
6. The six segments in the display will cycle until they all go off in a similar way to the pre-heat cycle but without showing the  icon.
7. When the coffee is ready, all six segments will have gone off and the  icon will come on.
- Note that if your Espresso maker needs to pre-heat once the coffee is brewed, the pre-heat icon  will show instead of the ready icon .

## Manual Mode

This mode allows you to control the amount of coffee your Espresso maker dispenses.

1. Fill the water tank, then add the required amount of coffee to the portafilter and fit it.
2. Place one or two cups onto the drip tray.
3. Press and hold the  button. The button light will come on.
4. Hold the button until the required amount of coffee has been dispensed.

### Notes

- The maximum run time in manual mode is 60 seconds.
- The display will show a single segment at a time in a moving anticlockwise pattern while the button is held down.





---

## STEAM/HOT WATER FUNCTIONS

The steam/hot water functions can be used to heat milk, froth milk and heat drinks that have cooled.

**Important:** The appliance requires a short cooling period after the steaming or frothing function is completed and will not be able to brew immediately.

### Steaming milk

1. Press the steam button .
2. The six segments in the display and the  icon will light up. The first segment will flash. The flashing segment will go off and the next anticlockwise segment will flash. When all of the segments have gone off, and the  icon comes on, your Espresso maker is ready to make steam.
3. Fill a small jug with milk.
4. Hold the jug under the steam nozzle with the nozzle beneath the surface of the milk.
5. Turn the steam/hot water control counterclockwise. The further counterclockwise you turn the control, the more steam is produced.
6. When the milk is heated to your satisfaction, turn the steam/hot water control clockwise to the off () position.

7. Clean the steam nozzle.

### **Frothing milk**

1. Follow steps 1 and 2 under 'Steaming milk'. Use cold milk from the refrigerator for best results.
2. Hold the jug under the nozzle as above and open the steam/hot water control as desired.
3. To make frothy milk with large bubbles, hold the nozzle just under the surface of the milk and make circular motions with the jug as steam is released (Fig. L).
4. To make frothy milk with small bubbles (micro foam), hold the nozzle fully under the surface of the milk and make circular motions with the jug as steam is released (Fig. M).
5. Turn the steam/hot water control clockwise to the off (○) position when you are finished.
6. Clean the steam nozzle.

### **Hot water**

1. Follow steps 1 and 2 under 'Steaming milk'.
2. Hold a suitable container under the steam nozzle.
3. Turn the steam/hot water control fully counterclockwise to the /○ position.
4. Hot water will come out of the steam nozzle for up to 90 seconds.
5. Turn the steam/hot water control clockwise to the off (○) position when you are finished.

### **Heating drinks**

- Follow the directions under 'Steaming milk' but holding the cooled drink under the steam nozzle instead of the milk.

### **Cleaning the steam nozzle after each use**

1. Clean the steam nozzle and the swivel arm immediately after every use.
2. Immerse the steam nozzle in a cup of clean water.
3. Turn the steam/hot water control counterclockwise. Let steam escape into the clear water for several seconds.
4. Repeat the process several times if necessary.
5. Finally, carefully remove the steam nozzle and wipe it and the swivel arm with a clean damp cloth before replacing it.

---

## **TIPS**

- Place your espresso cups on top of the unit where they will be gently warmed.
- To get a hotter espresso, warm the portafilter before use. Fit the sieve into the portafilter, fit the portafilter and run the brewing process for 5-10 seconds to heat the filter up. Then, remove the portafilter and use it as normal to make espresso. Be aware when handling the portafilter and sieve that they will be hot after doing this.
- After several uses of the steam function, the temperature of the unit can become high and this will prevent further brewing until the machine has cooled a little. You can use the hot water function to cool the machine more quickly.

---

## **CARE AND MAINTENANCE**

### **Cleaning**

1. Unplug the appliance and let it completely cool down.
2. Clean the exterior surfaces and the steam nozzle with a slightly damp cloth and then dry them thoroughly. Make sure that no water enters the product interior (for example, through the control opening). The steam nozzle tip can be removed by pulling it downwards and it can then be washed separately.
3. Remove the portafilter and sieve and empty out the coffee grounds. Wash under running water and dry thoroughly.





4. Wipe the area on the machine where the portafilter fits.
5. Empty the drip tray when you have finished using the machine, or when the drip tray full indicator pops up.
  - Use the cleaning tool to unblock the openings in the portafilter.
  - The steam nozzle, sieves, drip tray and drip tray cover can be cleaned in a dishwasher.

## Descaling

After approximately 500 cycles, the clean icon  will appear in the display indicating that the unit should be descaled. This is a warning and will not affect coffee making but the icon will remain lit until it is reset after descaling the appliance.

Never use a descaling product based on mineral acids such as sulphuric acid, hydrochloric acid, sulphamic acid and acetic acid (e.g. vinegar). These descalers may damage the machine. Use a descaling product recommended for appliances with plastic parts.

Products returned under guarantee with faults due to scale will be subject to a repair charge.

- Descale your product regularly depending on your water's lime content and frequency of use.
- Use a proprietary descaling product and follow the manufacturer's instructions.
  1. Pour fresh water and the specified amount of decalcifier into the water tank.
  2. Repeatedly start the brewing process and also use the 'hot water' process to clean the steam nozzle and internal components.
  3. Do this until the water tank is empty. If necessary, repeat this process.
  4. After descaling, rinse the product several times by brewing water with no coffee to remove any decalcifier residue.
  5. To reset the light, hold the / button and the manual /☹ button at the same time for 5 seconds. The clean icon  will go off.

---

## TROUBLESHOOTING

The caution (!) icon will appear in the display under the following circumstances:

Cause	Solution
The steam/hot water control is in the open position during brewing.	Close the control.
Manual brewing longer than 60 seconds.	Don't hold the  /☹ button for longer than 60 seconds in manual mode.
Steaming longer than 180 seconds.	Don't use the steam/hot water control for longer than 180 seconds.
Hot water dispensed for longer than 90 seconds.	Don't try to dispense hot water for longer than 90 seconds.
The steam/hot water control is in the open position when the unit is switched on.	The unit will not brew. Close the control.



The pre-heat (☺☺☺) icon and the countdown display segments along with the flashing caution (!) icon will appear in the display under the following circumstances:

<b>Cause</b>	<b>Solution</b>
Attempting to brew coffee before the unit has reached the correct temperature.	Allow the unit to pre-heat fully indicated by the ☺☺☺ icon.
Attempting to create steam before the unit has reached the correct temperature.	Allow the unit to reach the correct temperature indicated by the ☺☺☺ icon.
Attempting to dispense hot water before the unit has reached the correct temperature.	Allow the unit to reach the correct temperature indicated by the ☺☺☺ icon.

## General

<b>Problem</b>	<b>Possible Cause</b>	<b>Solution</b>
No espresso is made	Water tank empty	Fill the water tank
	Portafilter or sieve is blocked	Remove and clean
	Machine needs descaling	Descal the machine
	Grind is too fine or coarse	Grind the coffee to the correct consistency
Espresso leaks from around the portafilter	The portafilter is not fitted correctly	Remove and refit the portafilter. Make sure it is turned fully to the right until it won't turn any further.
Portafilter can't be fitted	Too much coffee in the sieve	Use the supplied measure/ tamper as directed.
	Debris around the portafilter fitting	Clean the area where the portafilter fits
Coffee tastes weak	Not enough coffee in the sieve	Use the supplied measure/ tamper as directed.
	Grind is too fine or coarse	Grind the coffee to the correct consistency
	Coffee too loose in sieve	Tamp the coffee down with more pressure



---

## RECYCLING

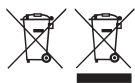

To avoid environmental and health problems due to hazardous substances, appliances and rechargeable and non-rechargeable batteries marked with one of these symbols must not be disposed of with unsorted municipal waste. Always dispose of electrical and electronic products and, where applicable, rechargeable and non-rechargeable batteries, at an appropriate official recycling/collection point.

---

## SERVICE

If you ring Customer Service, please have the Model Number to hand, as we won't be able to help you without it. It's on the rating plate (usually underneath the product).

The product isn't user-serviceable. If it's not working, read the instructions, check the plug fuse and main fuse/circuit breaker. If it's still not working, consult your retailer.

If that doesn't solve the problem – ring Customer Service – they may be able to offer technical advice.

If they advise you to return the product to us, pack it carefully, include a note with your name, address, day phone number, and what's wrong. If under guarantee, say where and when purchased, and include proof of purchase (till receipt). Send it to:

Customer Service

Spectrum Brands (UK) Ltd

Fir Street, Failsworth, Manchester M35 0HS

email: [support@russellhobbs.com](mailto:support@russellhobbs.com)

telephone: 0345 658 9700 (local rate number)

Please note: If you have purchased the product within the last 6 months, please contact the retailer in the first instance to deal with any matters relating to warranty.

---

## GUARANTEE

Defects affecting product functionality appearing within the guarantee period will be corrected by replacement or repair at our option provided the product is used and maintained in accordance with the instructions. Your statutory rights are not affected.

This warranty shall not be valid where it is contrary to U.S. and other applicable laws, or where the warranty would be prohibited under any economic sanctions, export control laws, embargos, or other restrictive trade measures enforced by the United States or other applicable jurisdictions. This includes, without limitation, any warranty claims implicating parties from, or otherwise located in, Cuba, Iran, North Korea, Syria and the Crimea region.

Guarantee period = 2 years from first retail purchase.

To claim an extra 1 year guarantee, register your product online within 28 days of purchase.

Register at: [uk.russellhobbs.com/product-registration](http://uk.russellhobbs.com/product-registration)

Consumables are guaranteed only for their recommended lifecycle. Replacement/Spare parts\* are excluded and are only covered by a 1 year warranty.

\* Examples include filters, removable grill plates, drip trays/crumb trays etc.

---

## ONLINE

[www.russellhobbs.com](http://www.russellhobbs.com) for more products

**BEAUTIFULLY BRITISH IDEAS**  
**SINCE**  
  
**1952**